

# Unitech Screw Aggregates Series 300A Models PV300AS

## APPLICATION:

Transportation of fluids with viscosity up to 250 Pa.s. The aggregate consists of screw pump with hopper and feeding screw device.



## STANDARD EQUIPMENT:

Mobile single screw pumps with hopper and feeding screw device. Feet– For decreasing vibration at work.

CIP – Hopper with drain

Starter with reverse and emergency stop

Material AISI 304 / NBR

Inlet/ Outlet: Hopper 0.1 m<sup>3</sup>/ male union joints DIN 11851

**\*AS-modification** (Handle in front of the hopper)

## OPTIONS:

**\*Hopper extension on Request**

**\* 2 speed el. motor**

**\*Inverter/Frequency control** – Electrical variable speed

**\*Lc** – Level control min/ max hopper level

**\*Tc** – Temperature control protective dry run

Material AISI 316

Connection: Garolla, SMS, Macon, Clamp, etc.

**\*Other Options on Request**

| Technical Parameters |                      |                  |                |     |                      |                |        |
|----------------------|----------------------|------------------|----------------|-----|----------------------|----------------|--------|
| Model                | Capacity             | Nominal Pressure | Electric Motor |     | Hopper's Volume      | Viscosity      | Weight |
|                      |                      |                  | kW             | RPM |                      |                |        |
| PV308AS7             | 7 m <sup>3</sup> /h  | 4.0 bar          | 3.0            | 144 | 0.075 m <sup>3</sup> | up to 250 Pa.s | 180 kg |
| PV308AS10            | 10 m <sup>3</sup> /h |                  | 3.0            | 206 | 0.075 m <sup>3</sup> |                | 180 kg |
| PV305AS15            | 15 m <sup>3</sup> /h |                  | 4.0            | 144 | 0.09 m <sup>3</sup>  |                | 240 kg |
| PV305AS20            | 20 m <sup>3</sup> /h |                  | 5.5            | 206 | 0.09 m <sup>3</sup>  |                | 245 kg |
| PV306AS25            | 25 m <sup>3</sup> /h |                  | 7.5            | 144 | 0.1 m <sup>3</sup>   |                | 280 kg |
| PV306AS30            | 30 m <sup>3</sup> /h |                  | 7.5            | 206 | 0.1 m <sup>3</sup>   |                | 280 kg |
| PV307AS30            | 30 m <sup>3</sup> /h |                  | 7.5            | 144 | 0.1 m <sup>3</sup>   |                | 325 kg |
| PV307AS40            | 40 m <sup>3</sup> /h |                  | 11.0           | 206 | 0.1 m <sup>3</sup>   |                | 335 kg |
| PV309AS50            | 50 m <sup>3</sup> /h |                  | 15.0           | 145 | 0.14 m <sup>3</sup>  |                | 470 kg |
| PV309AS60            | 60 m <sup>3</sup> /h |                  | 15.0           | 209 | 0.14 m <sup>3</sup>  |                | 480 kg |

Characteristic Curves of the Unitech Screw Aggregates Series 300A

Model PV308

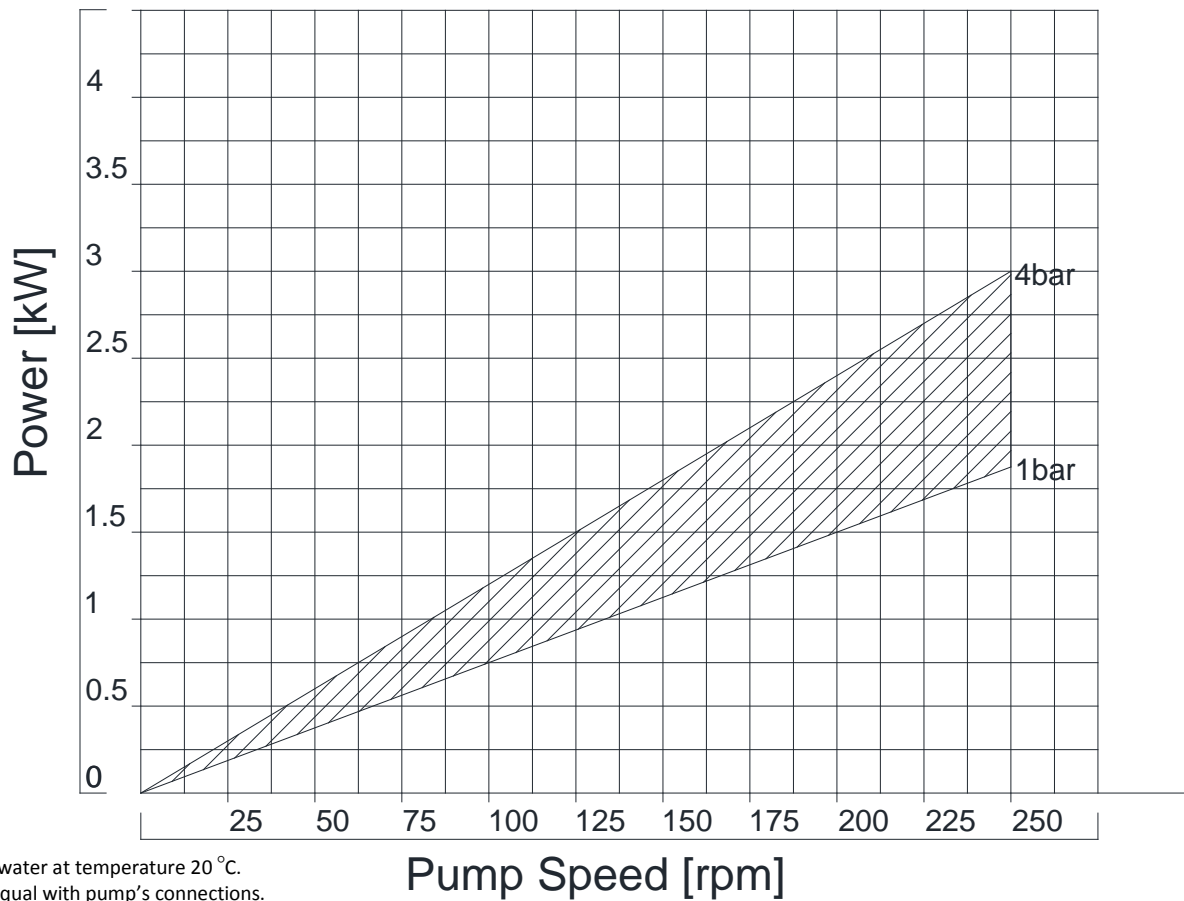
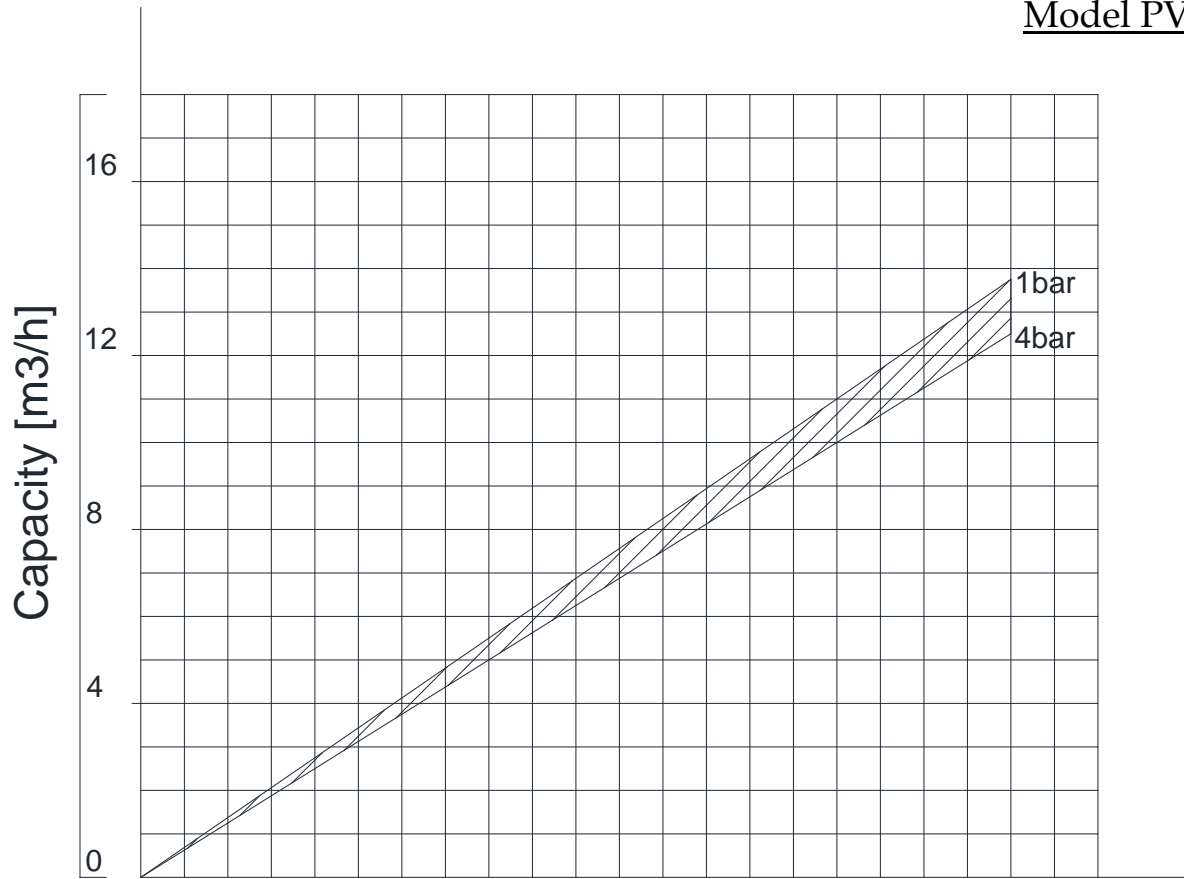

\*with fluid – water at temperature 20 °C.  
\*with pipes equal with pump's connections.

Characteristic Curves of the Unitech Screw Aggregates Series 300A  
Model PV305

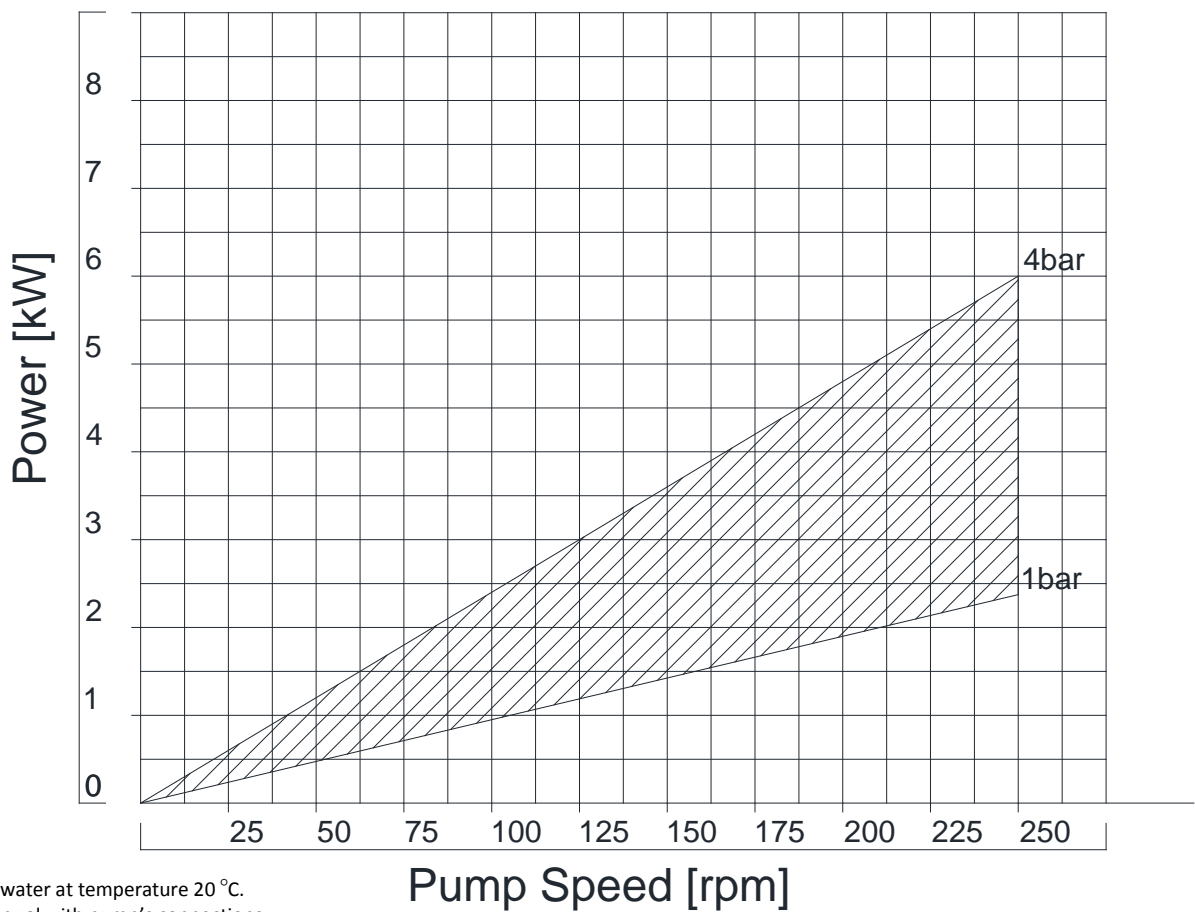
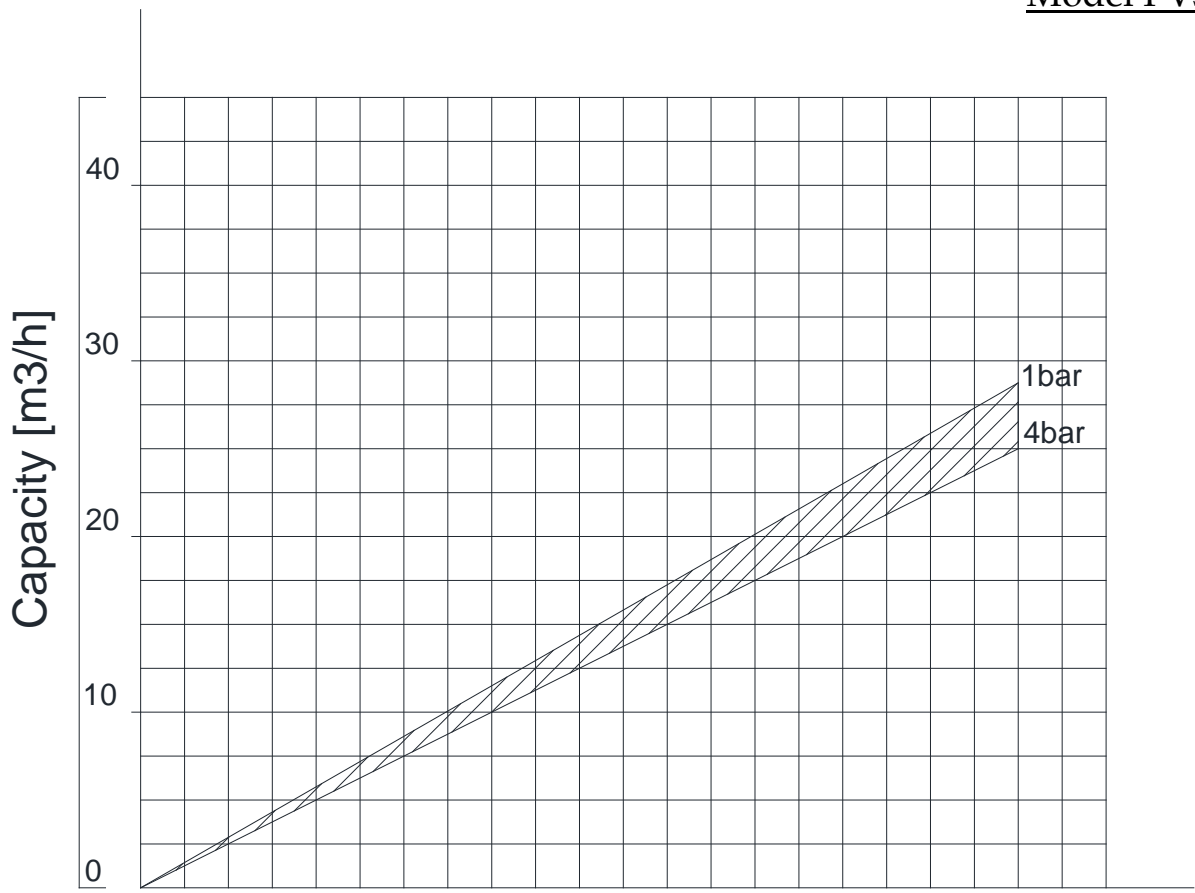

\*with fluid – water at temperature 20 °C.  
\*with pipes equal with pump's connections.

**Characteristic Curves of the Unitech Screw Aggregates Series 300A**  
**Model PV306**

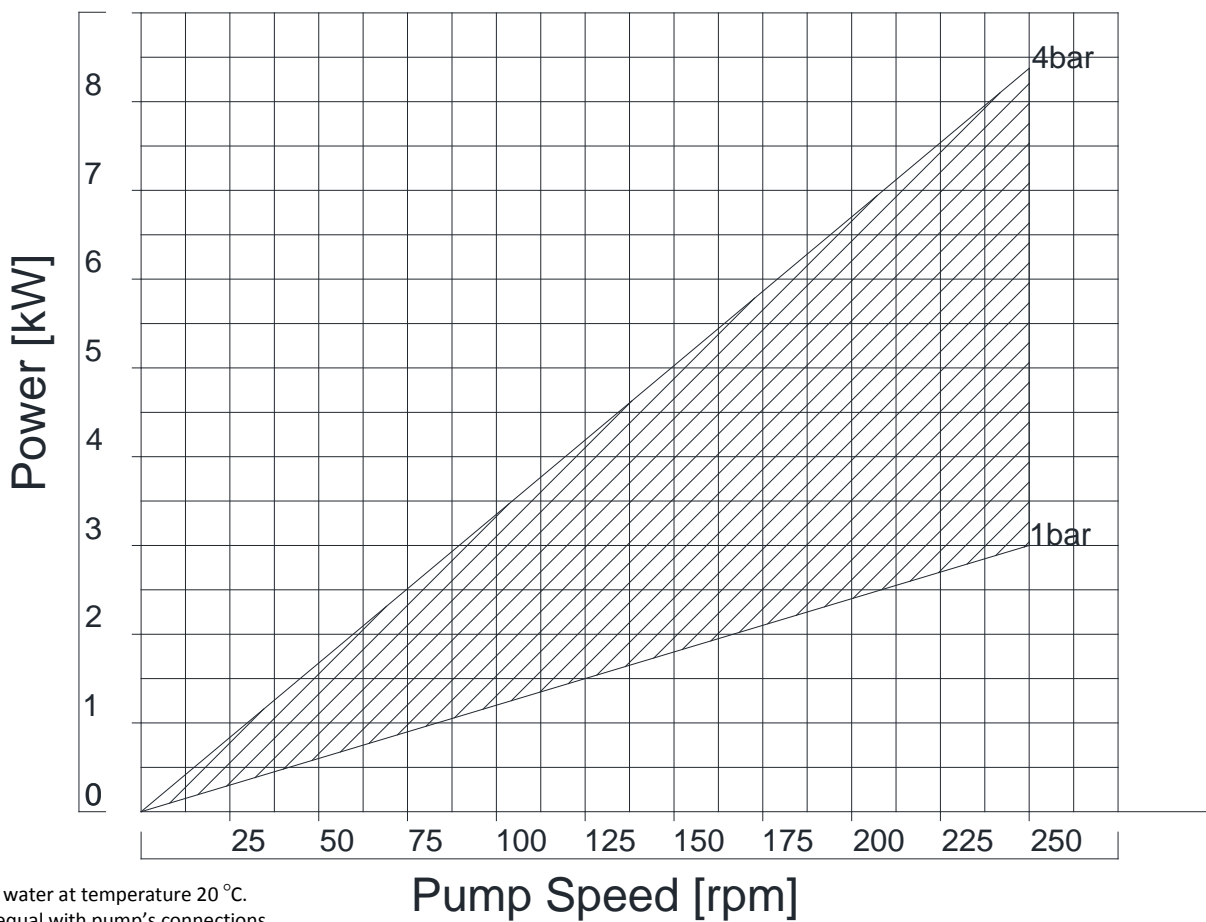
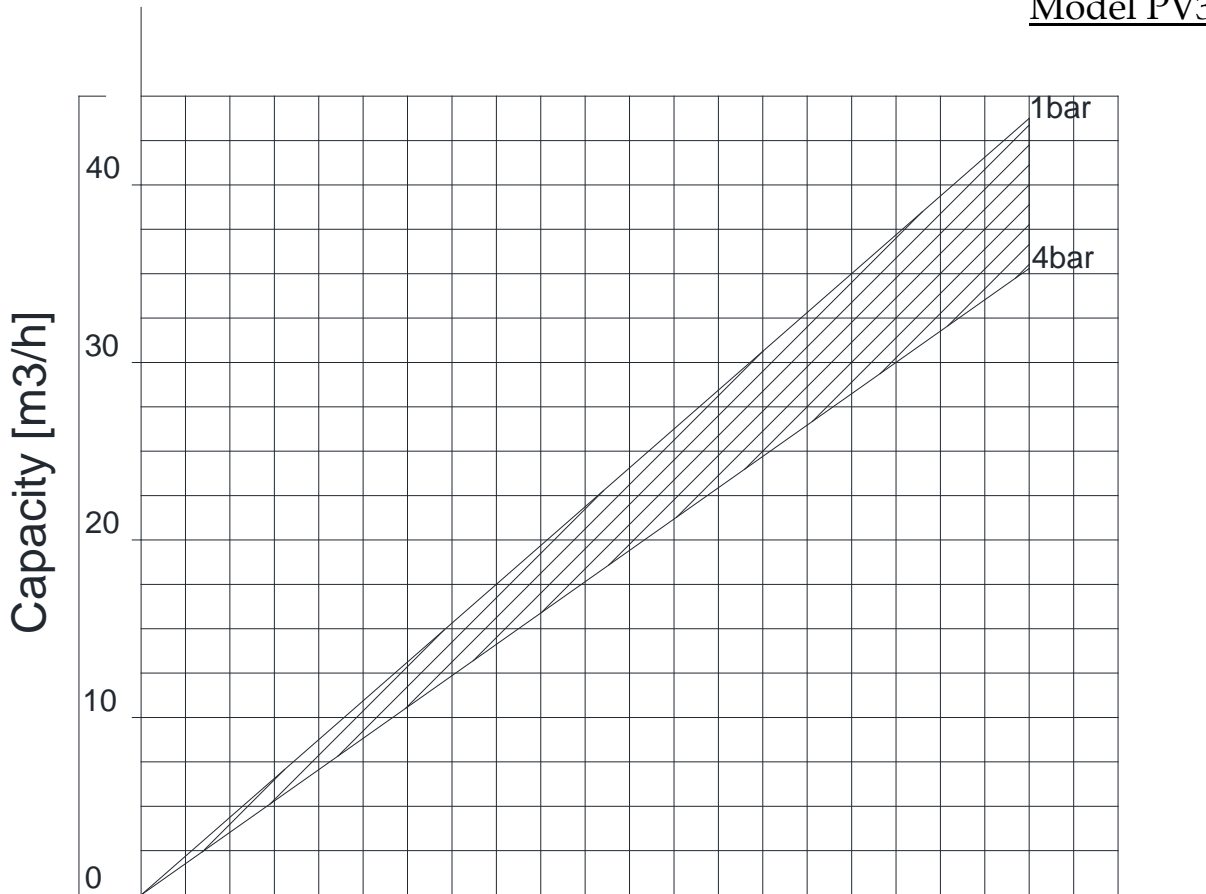

\*with fluid – water at temperature 20 °C.  
\*with pipes equal with pump's connections.

**Characteristic Curves of the Unitech Screw Aggregates Series 300A**  
**Model PV307**

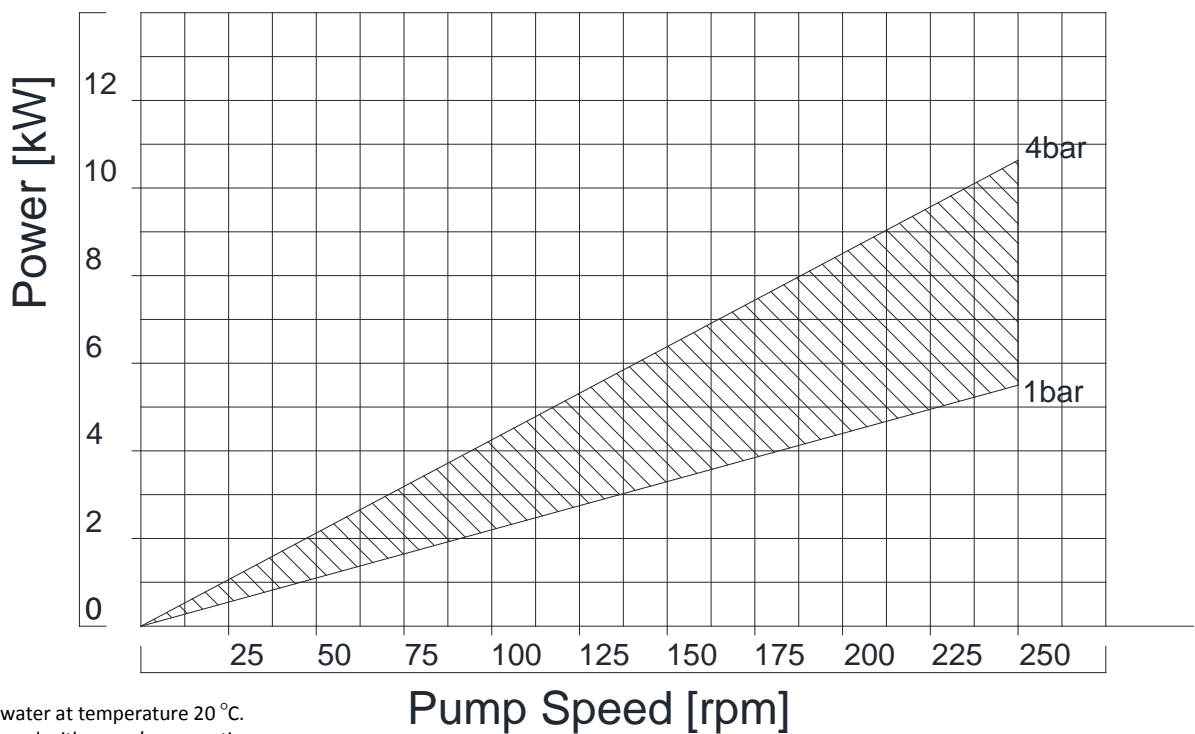
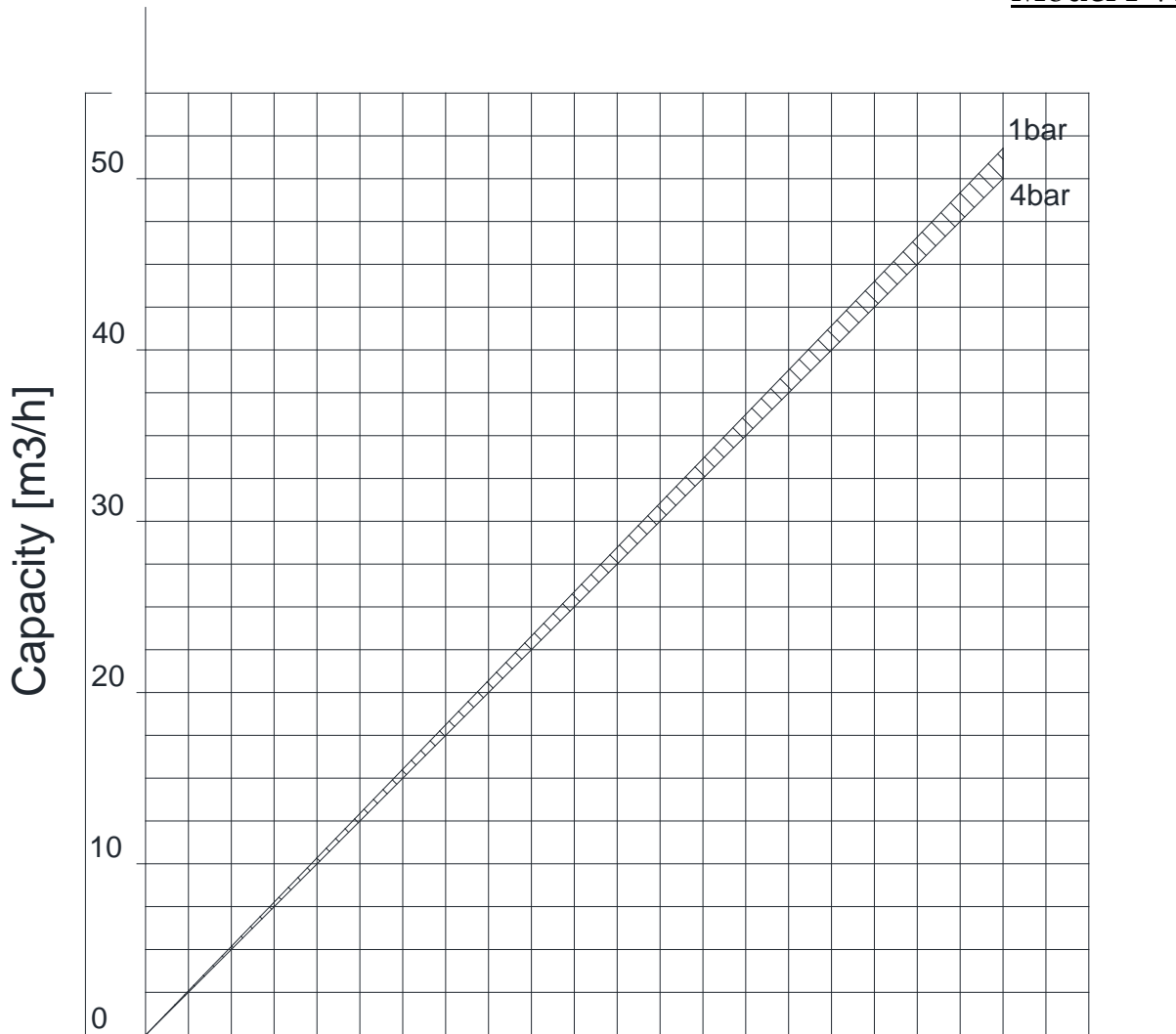

\*with fluid – water at temperature 20 °C.  
\*with pipes equal with pump's connections.

Characteristic Curves of the Unitech Screw Aggregates Series 300A  
Model PV309

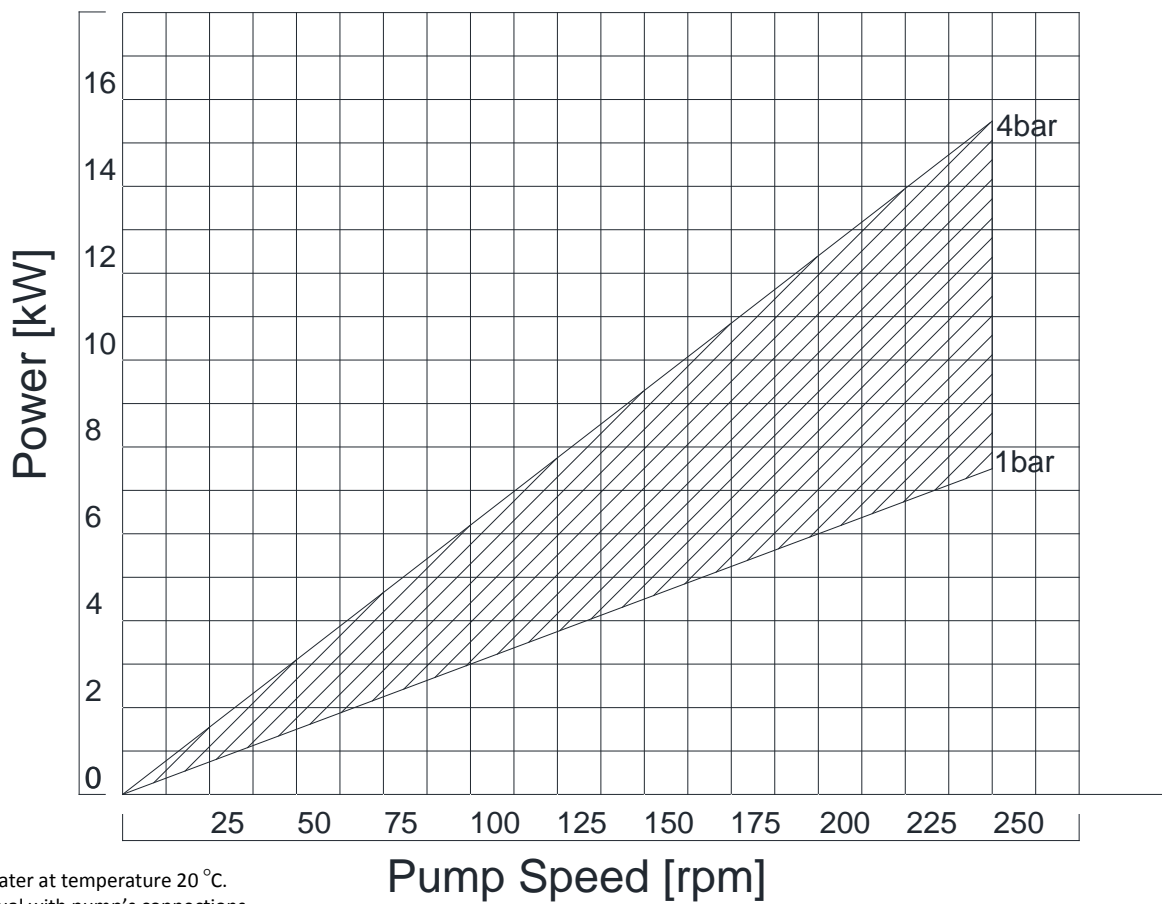
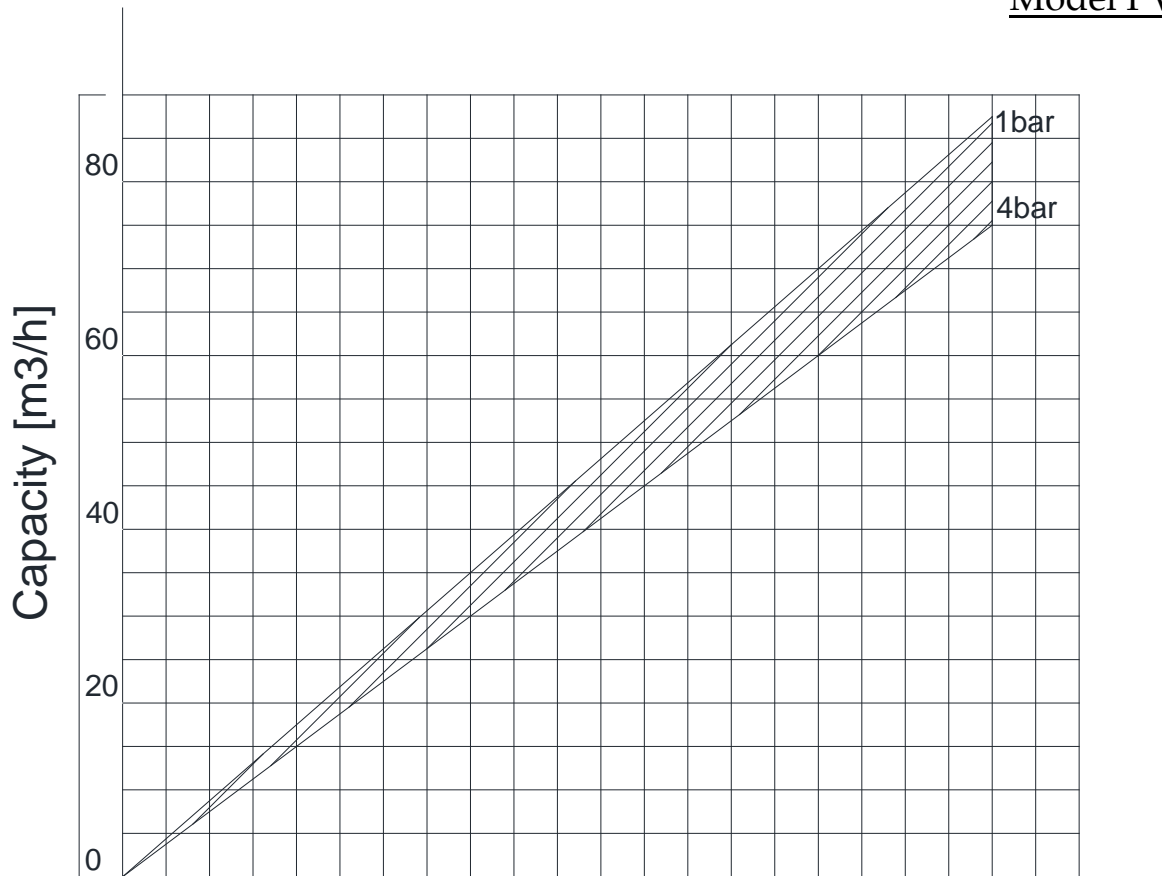

\*with fluid – water at temperature 20 °C.  
\*with pipes equal with pump's connections.

## Dimensions of the Unitech Screw Aggregates Series 300A

### Models PV300AS

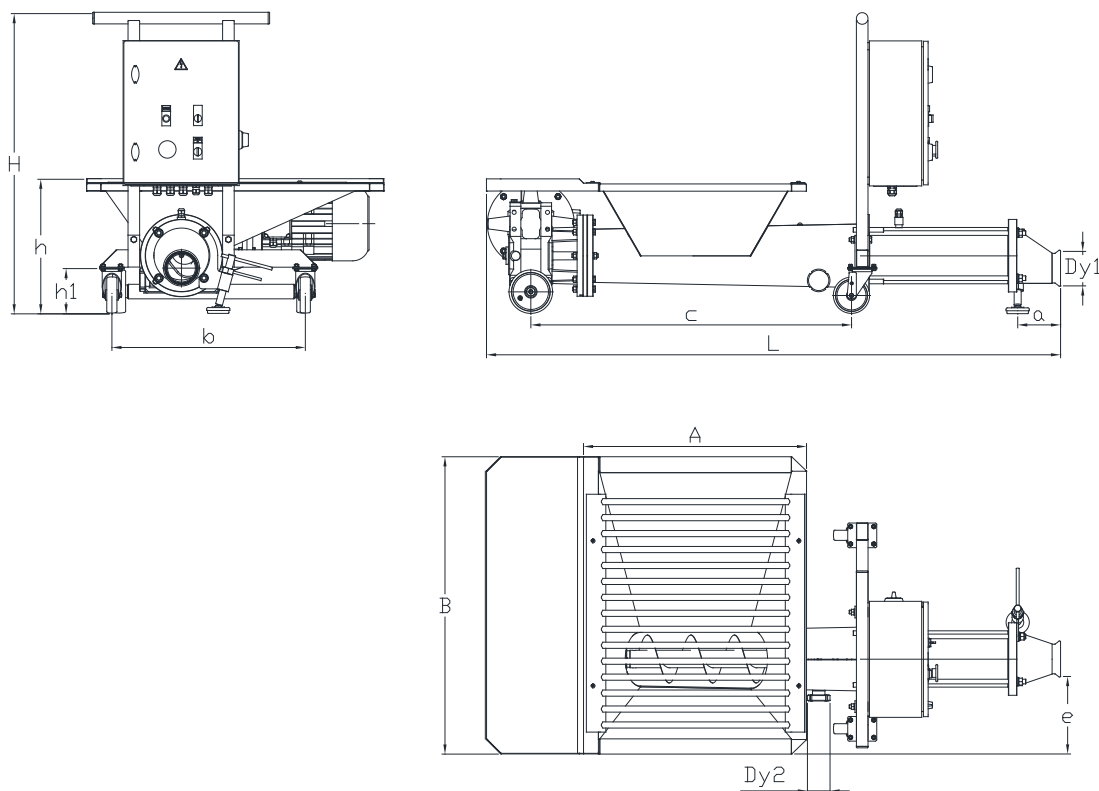

| Dimensions, mm |     |     |      |      |      |     |     |                 |     |     |      |     |     |
|----------------|-----|-----|------|------|------|-----|-----|-----------------|-----|-----|------|-----|-----|
| Model          | Dy1 | Dy2 | L    | B    | H    | A   | h   | h'              | h1  | b   | c    | a   | e   |
| PV308AS        | 100 | 40  | 1750 | 800  | 860  | 765 | 420 | up<br>to<br>740 | 150 | 670 | 1280 | -   | 330 |
| PV305AS        | 100 | 40  | 1950 | 930  | 925  | 765 | 450 |                 | 160 | 670 | 1180 | 150 | 330 |
| PV306AS        | 125 | 40  | 2030 | 1025 | 925  | 765 | 450 |                 | 155 | 670 | 1180 | 150 | 330 |
| PV307AS        | 125 | 40  | 2100 | 1025 | 925  | 765 | 450 |                 | 150 | 670 | 1180 | 150 | 330 |
| PV309AS        | 125 | 40  | 2630 | 1025 | 1050 | 920 | 575 |                 | 210 | 670 | 910  | 150 | 330 |

6600 Kardzhali, Bulgaria  
 East Industrial Zone  
 Post box 187  
 Tel: +35936166650  
 Fax: +35936166651  
 E-mail: [unitech@unitech.bg](mailto:unitech@unitech.bg)  
 Web: [www.unitech.bg](http://www.unitech.bg)