

# Unitech Screw Aggregates Series 300A

## Models PV300AV

### APPLICATION:

Transportation of fluids with viscosity up to 250 Pa.s. The aggregate consists of screw pump with hopper and feeding screw device.

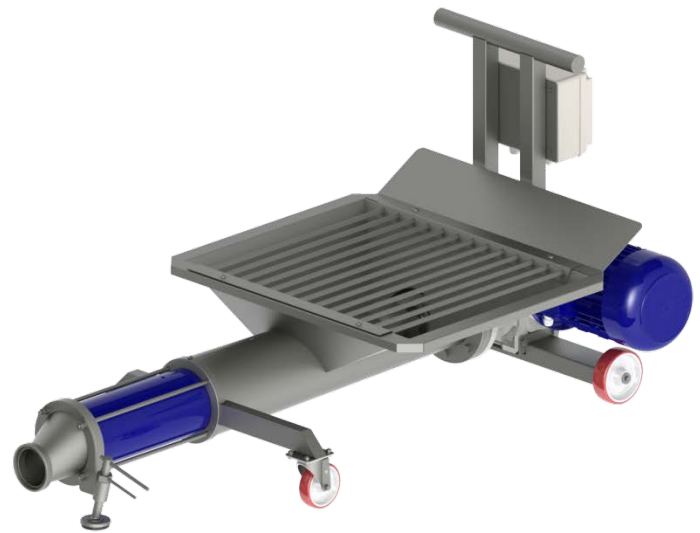

### STANDARD EQUIPMENT:

Mobile single screw pumps with hopper and feeding screw device. Feet– For decreasing vibration at work.  
 CIP – Hopper with drain  
 Starter with reverse and emergency stop  
 Material AISI 304 / NBR  
 Inlet/ Outlet: Hopper 0.1 m<sup>3</sup>/ male union joints DIN 11851  
**\*AV-modification** (Handle from behind the hopper)

### OPTIONS:

**\*Hopper extension on Request**  
**\* 2 speed el. motor**  
**\*Inverter/Frequency control** – Electrical variable speed  
**\*Lc** – Level control min/ max hopper level  
**\*Tc** – Temperature control protective dry run  
 Material AISI 316  
 Connection: Garolla, SMS, Macon, Clamp, etc.  
**\*Other Options on Request**

Technical Parameters							
Model	Capacity	Nominal Pressure	Electric Motor		Hopper's Volume	Viscosity	Weight
			kW	RPM			
PV308AV7	7 m <sup>3</sup> /h	4.0 bar	3.0	144	0.075 m <sup>3</sup>	up to 250 Pa.s	180 kg
PV308AV10	10 m <sup>3</sup> /h		3.0	206	0.075 m <sup>3</sup>		180 kg
PV305AV15	15 m <sup>3</sup> /h		4.0	144	0.09 m <sup>3</sup>		240 kg
PV305AV20	20 m <sup>3</sup> /h		5.5	206	0.09 m <sup>3</sup>		245 kg
PV306AV25	25 m <sup>3</sup> /h		7.5	144	0.1 m <sup>3</sup>		280 kg
PV306AV30	30 m <sup>3</sup> /h		7.5	206	0.1 m <sup>3</sup>		280 kg
PV307AV30	30 m <sup>3</sup> /h		7.5	144	0.1 m <sup>3</sup>		325 kg
PV307AV40	40 m <sup>3</sup> /h		11.0	206	0.1 m <sup>3</sup>		335 kg
PV309AV50	50 m <sup>3</sup> /h		15.0	145	0.14 m <sup>3</sup>		470 kg
PV309AV60	60 m <sup>3</sup> /h		15.0	209	0.14 m <sup>3</sup>		480 kg

## Characteristic Curves of the Unitech Screw Aggregates Series 300A

Model PV308

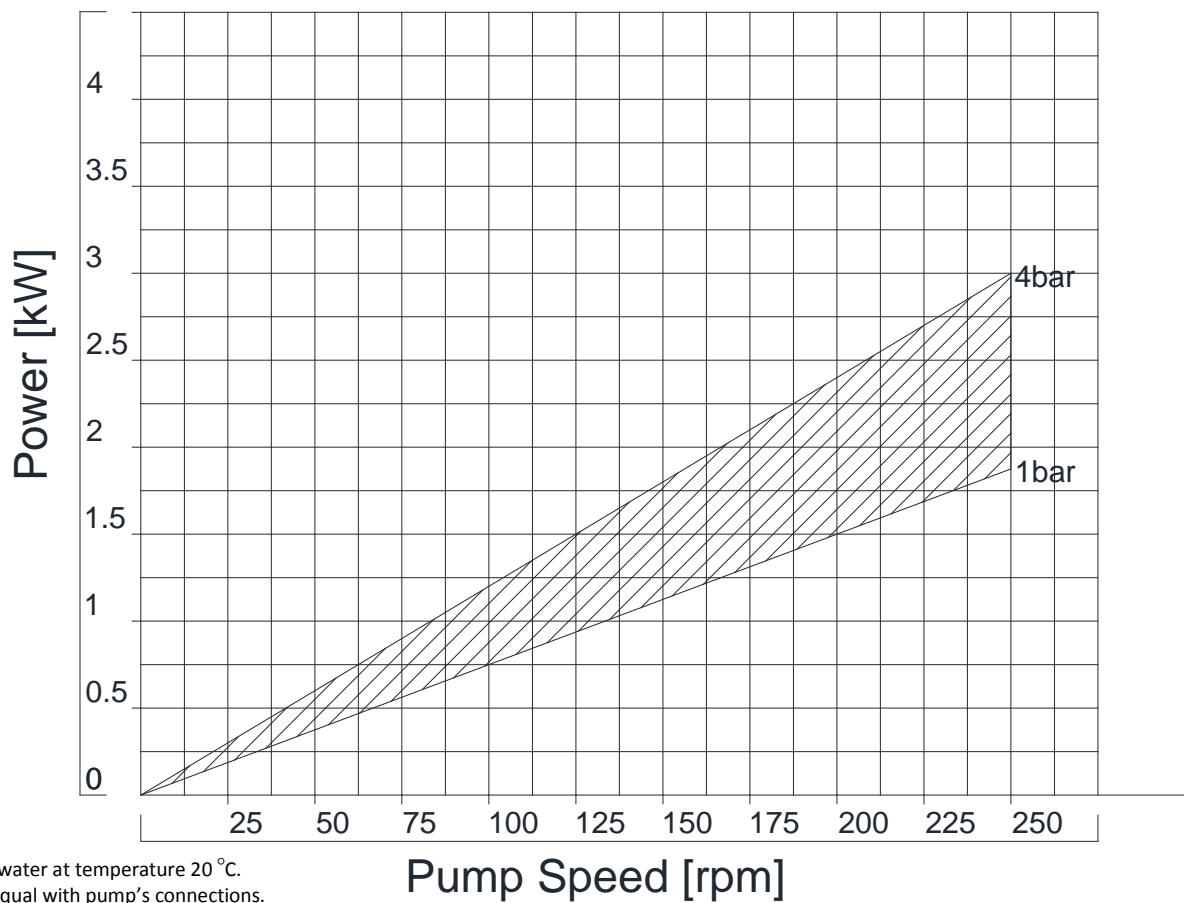
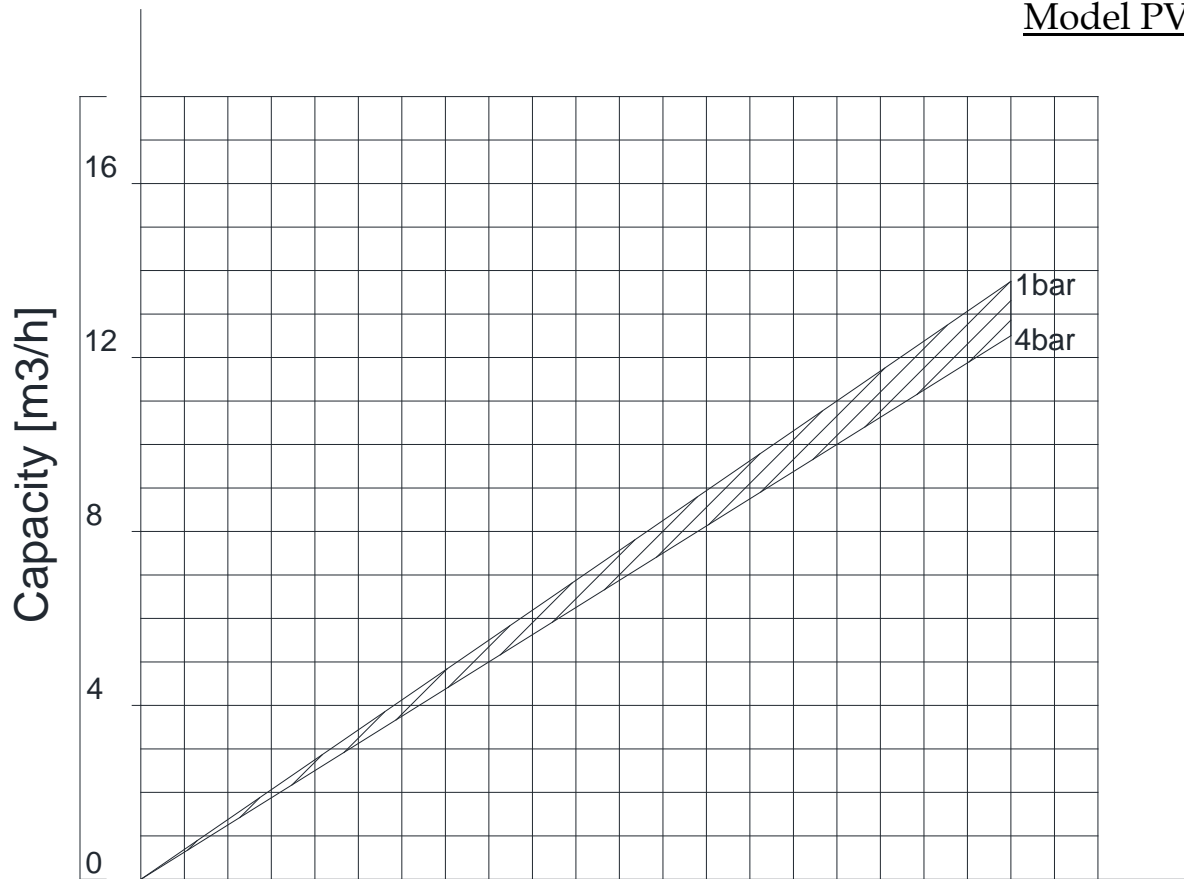

\*with fluid – water at temperature 20 °C.  
\*with pipes equal with pump's connections.

Characteristic Curves of the Unitech Screw Aggregates Series 300A  
Model PV305

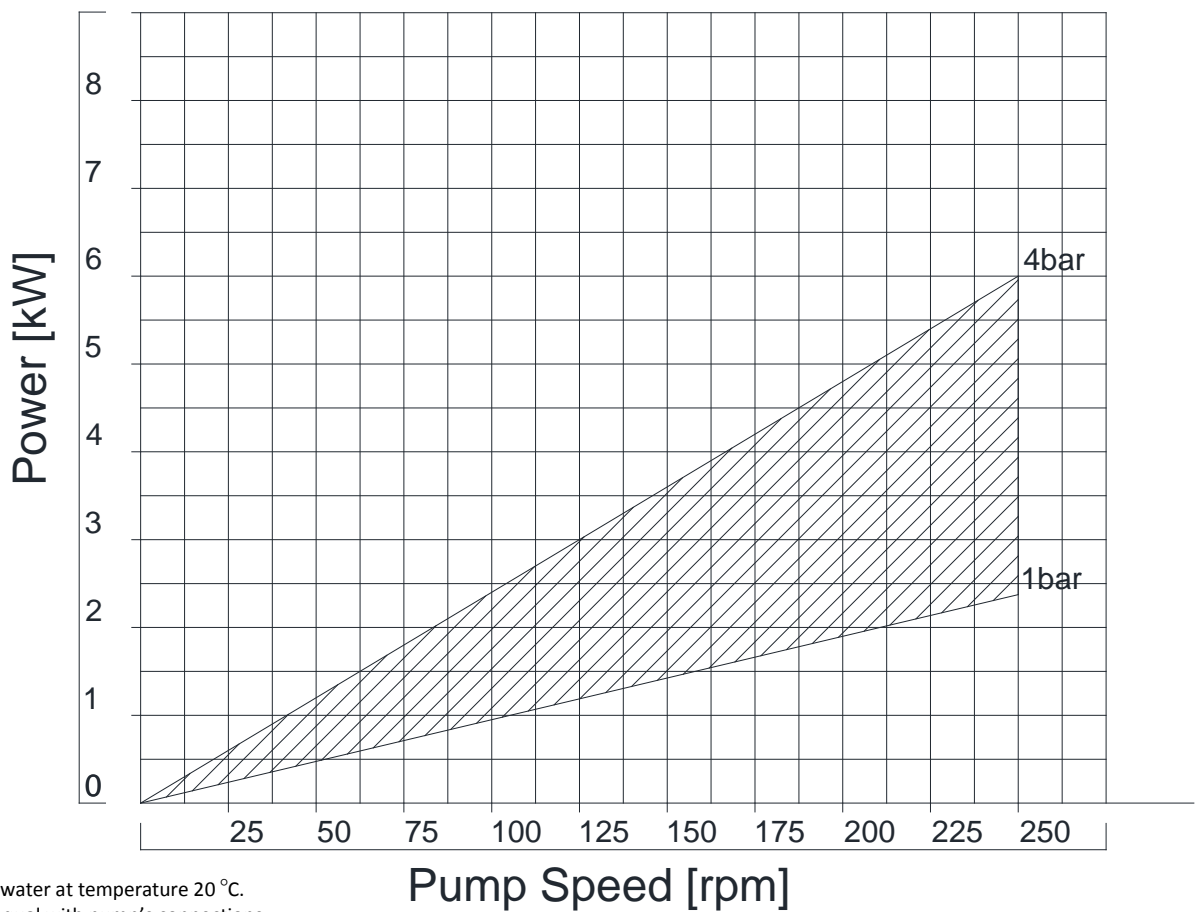
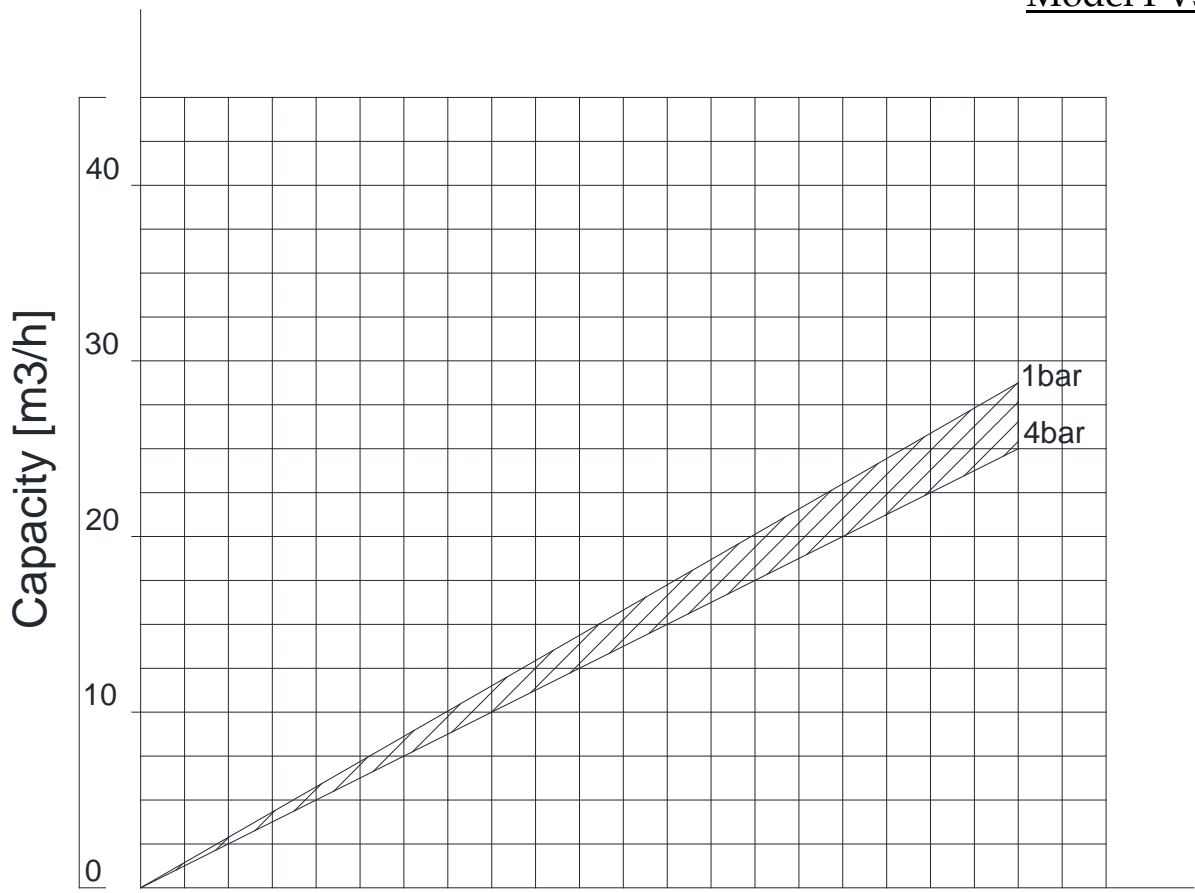

\*with fluid – water at temperature 20 °C.  
\*with pipes equal with pump's connections.

Characteristic Curves of the Unitech Screw Aggregates Series 300A  
Model PV306

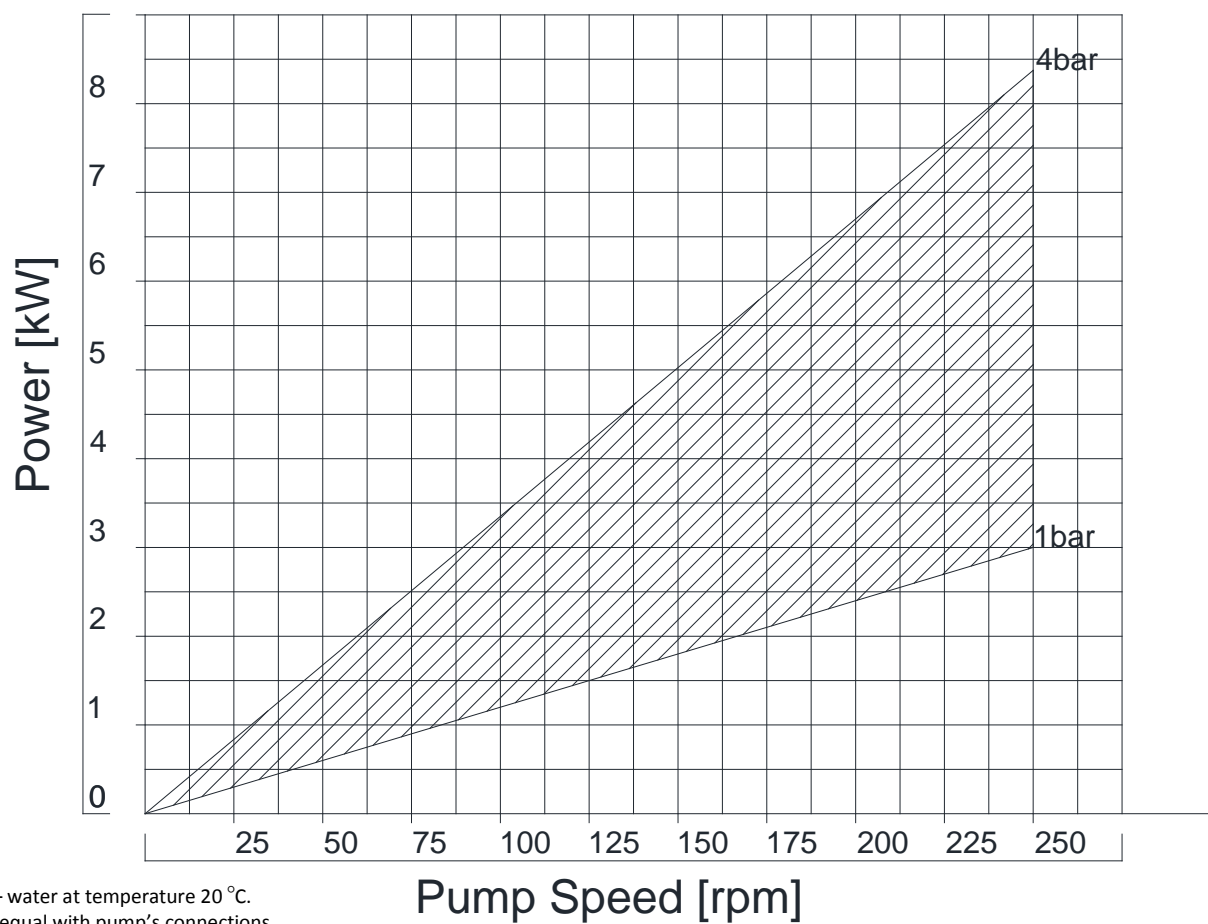
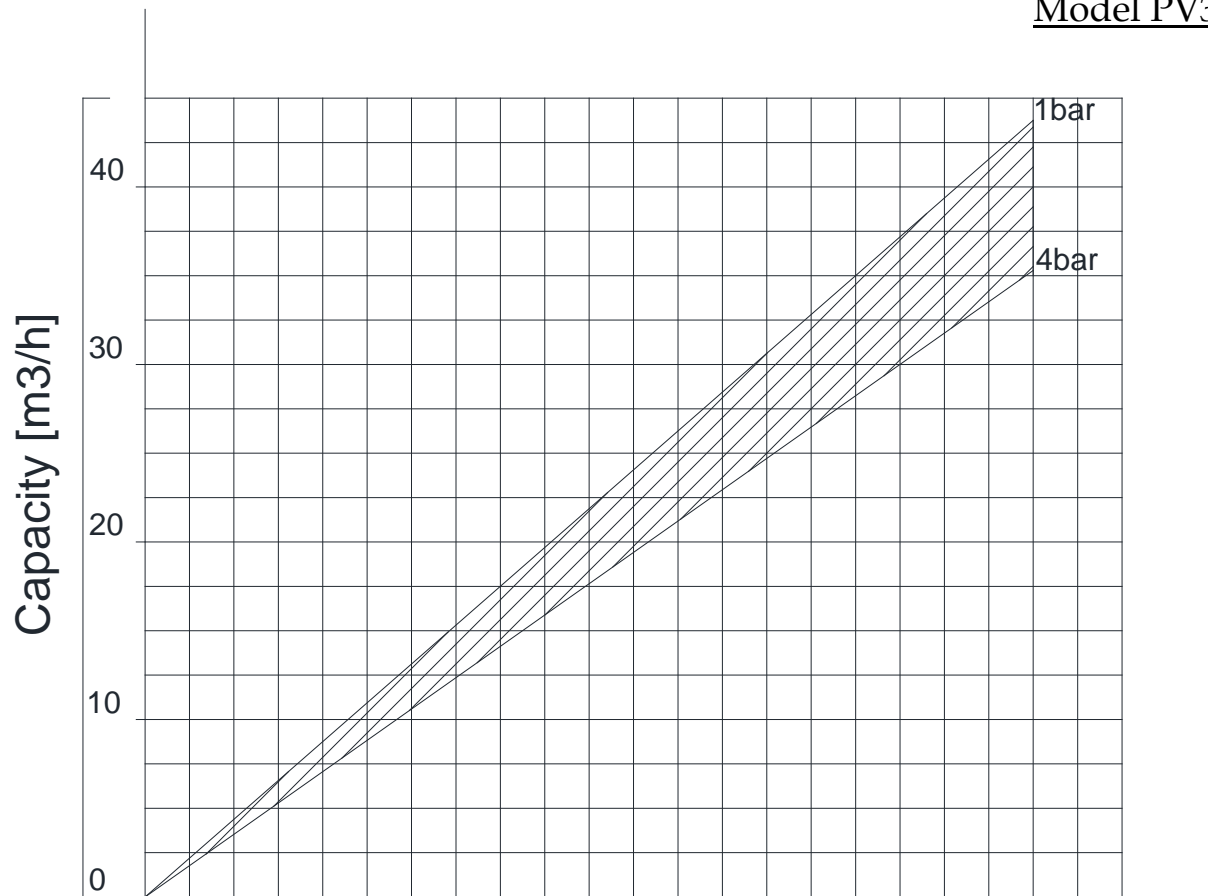

\*with fluid – water at temperature 20 °C.  
\*with pipes equal with pump's connections.

Characteristic Curves of the Unitech Screw Aggregates Series 300A  
Model PV307

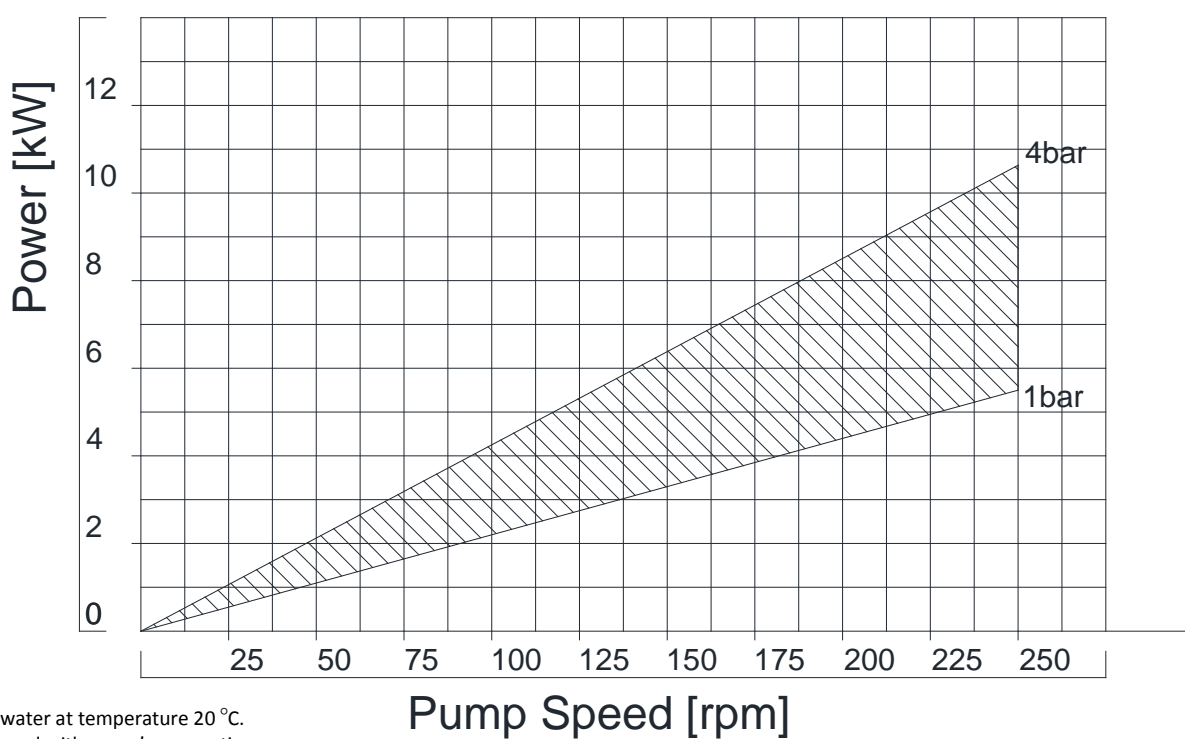
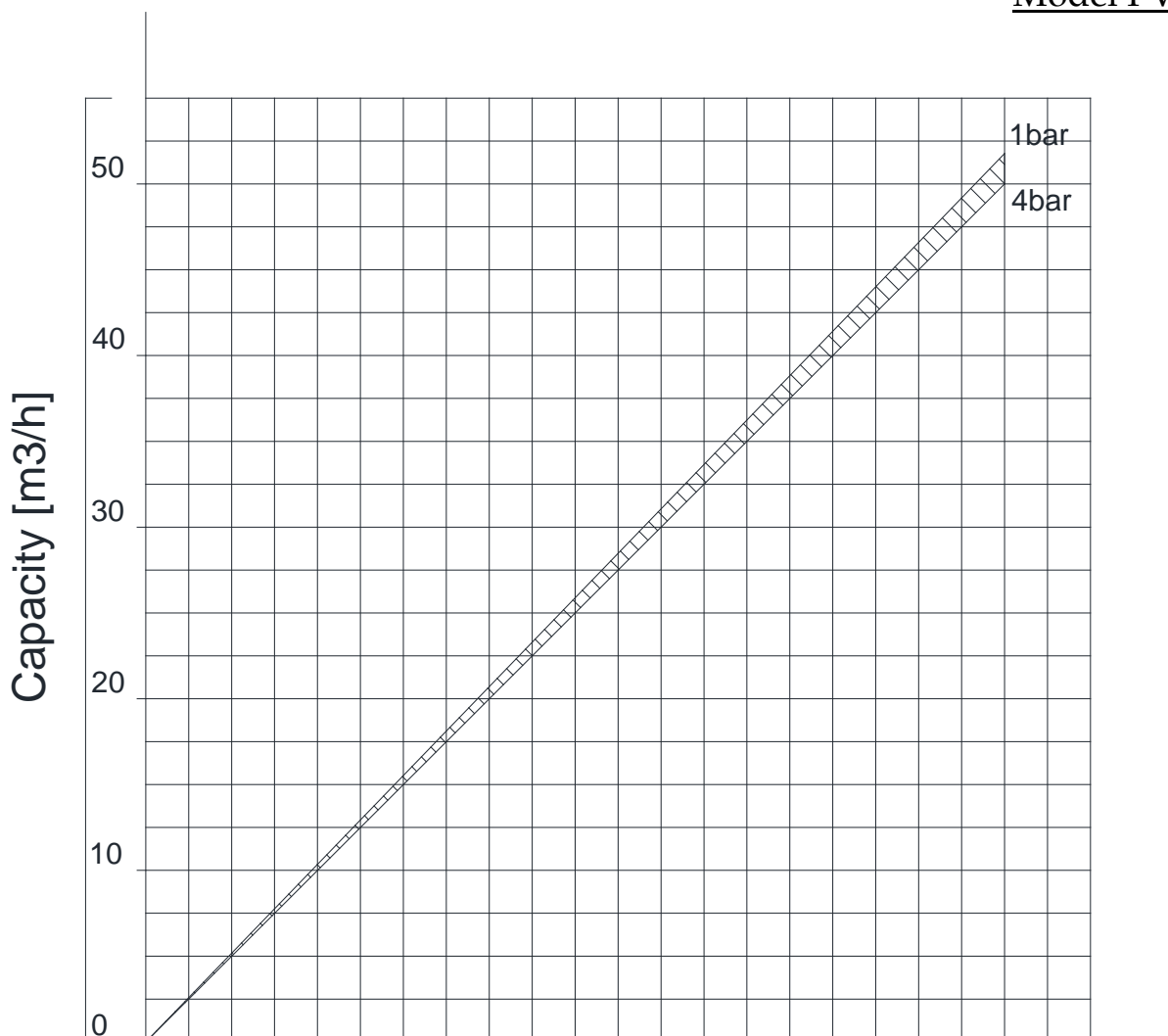

\*with fluid – water at temperature 20 °C.  
\*with pipes equal with pump's connections.

Characteristic Curves of the Unitech Screw Aggregates Series 300A  
Model PV309

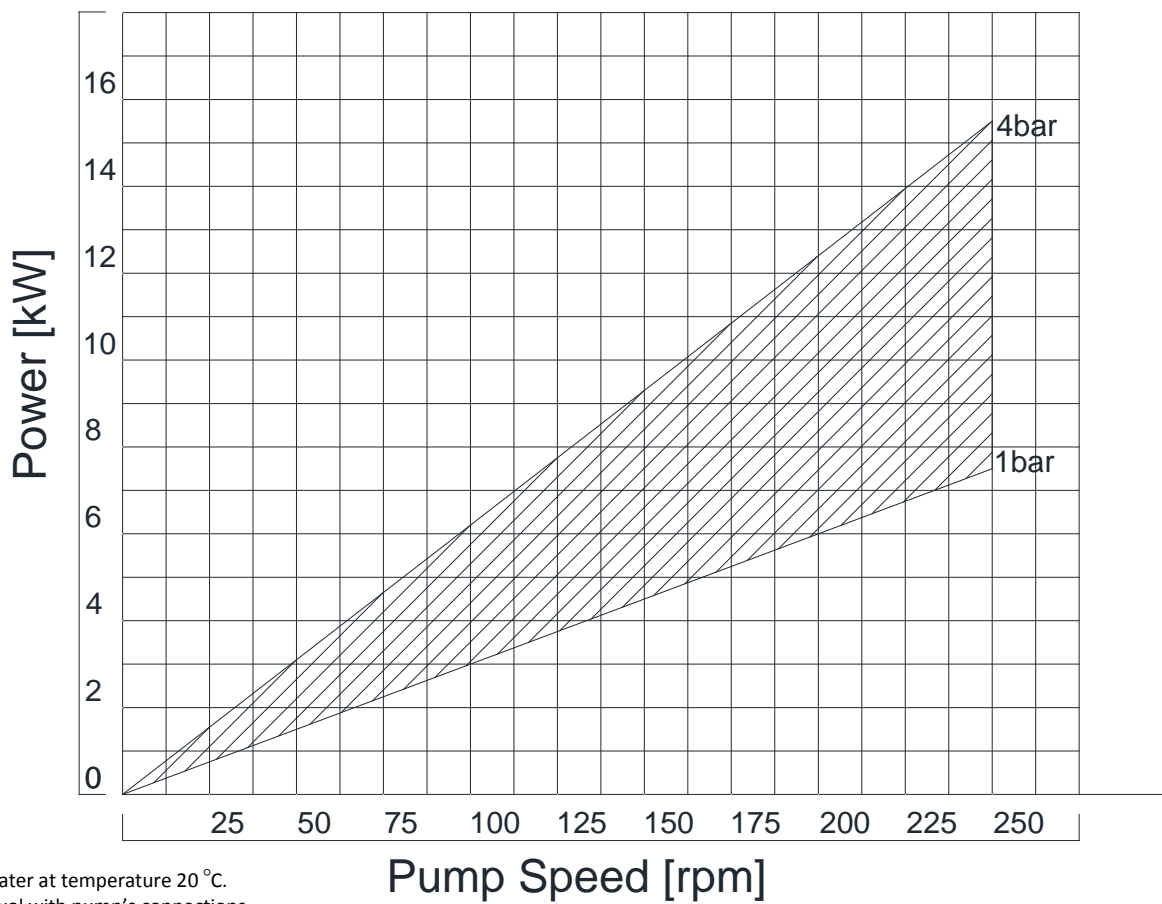
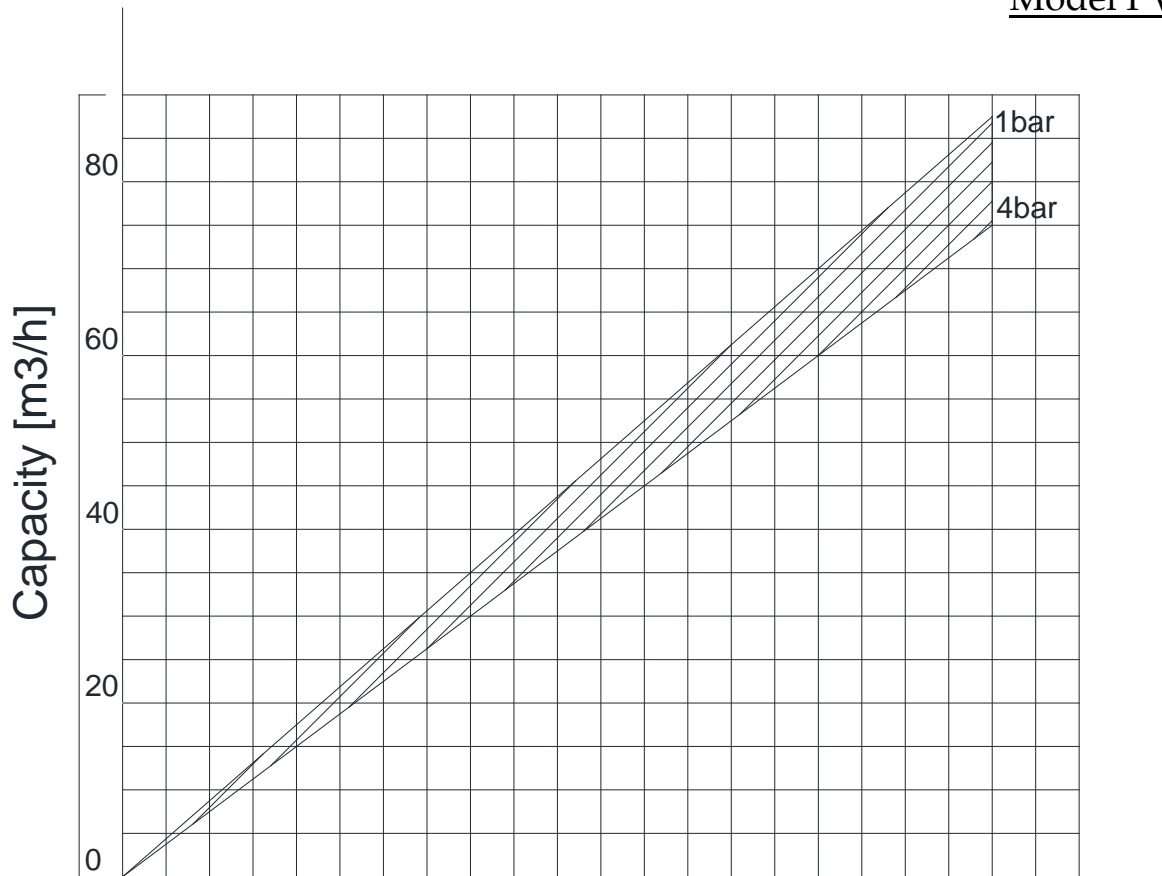

\*with fluid – water at temperature 20 °C.  
\*with pipes equal with pump's connections.

## Dimensions of the Unitech Screw Aggregates Series 300A Models PV300AV

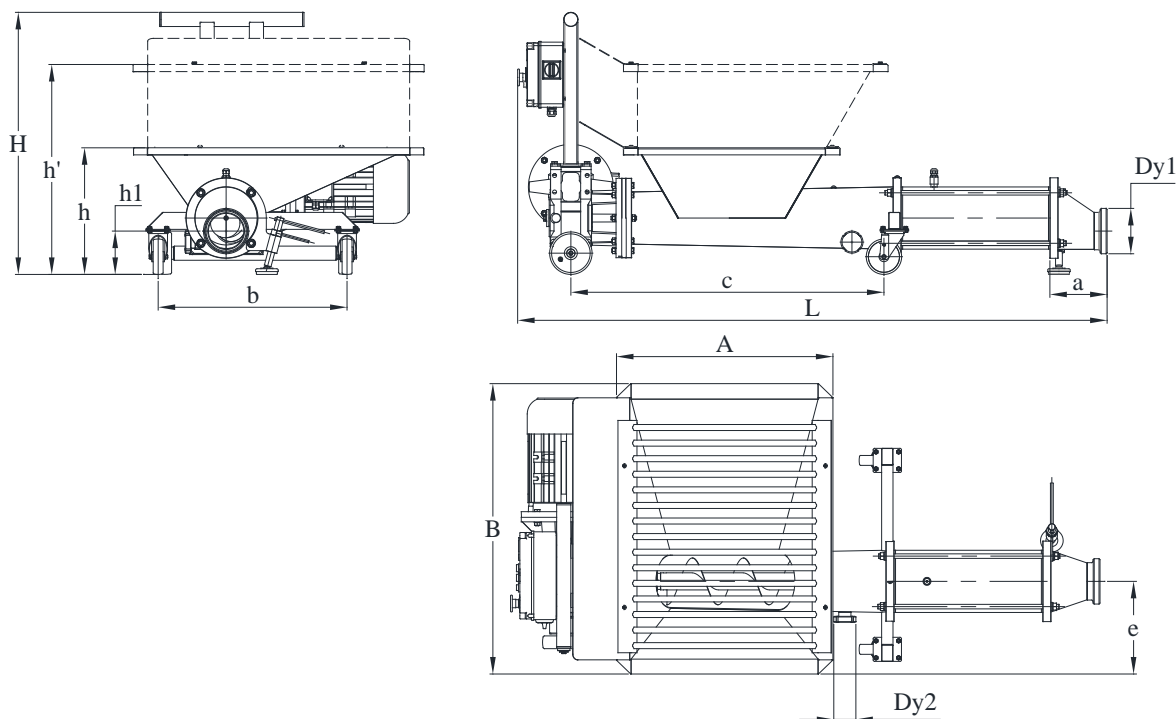

Dimensions, mm													
Model	Dy1	Dy2	L	B	H	A	h	h'	h1	b	c	a	e
PV308AV	100	40	1750	800	860	765	420	up to 740	150	670	1280	-	330
PV305AV	100	40	1950	930	925	765	450		160	670	1180	150	330
PV306AV	125	40	2030	1025	925	765	450		155	670	1180	150	330
PV307AV	125	40	2100	1025	925	765	450		150	670	1180	150	330
PV309AV	125	40	2630	1025	1050	920	575		210	670	910	150	330

6600 Kardzhali , Bulgaria  
 East Industrial Zone  
 Post box 187  
 Tel: +35936166650  
 Fax: +35936166651  
 E-mail: [unitech@unitech.bg](mailto:unitech@unitech.bg)  
 Web: [www.unitech.bg](http://www.unitech.bg)