

# Unitech Flexible Impeller Pumps Series 350 Models PL350K

## APPLICATION:

Transportation of fluids with viscosity up to 50 Pa.s and inserting of fractions corresponding with pump's technical parameters. Designed mainly for the food industry, these pumps also find application in other fields of usage.



## STANDARD EQUIPMENT:

Block pump – directly joined to the shaft of the electric motor.

**\*Mr-modification** (joined to the shaft of the gear-motor)

**\*K-modification** (mounted on a trolley with Starter)

Standing on heels of the el. motor.

Material AISI 304/ NBR

Inlet / Outlet: male union joints DIN 11851

## OPTIONS:

**\*B-modification** (By-pass with safety overflow valve)

**\*Se-modification** (with eccentric protective cover on the engine)

Material AISI 316

Connection: Garolla, SMS, Macon, Clamp, etc.

**\*Other Options on Request**

Technical Parameters								
Model	Capacity	Nominal Pressure	Electric Motor		Connection	Temperature	Viscosity	Weight
			kW	RPM				
PL350K	1 m <sup>3</sup> /h	1.0 bar	0.25	1350	male union joints DIN 11851	+2 ÷ +85°C	up to 50 Pa.s	8 kg
PL351K	3 m <sup>3</sup> /h		0.75	935				16 kg
PL352K	5 m <sup>3</sup> /h		1.1	930				18 kg
PL353K	7 m <sup>3</sup> /h		1.1	930				22 kg
PL354MRK	20 m <sup>3</sup> /h		2.2	770				42 kg
PL355MRK	35 m <sup>3</sup> /h		4.0	760				66 kg
PL356MRK	50 m <sup>3</sup> /h	1.0 (2.0) bar	7.5	540				140 kg
PL358MRK	80 m <sup>3</sup> /h		11.0	550				163 kg

Characteristic Curves of the Unitech Flexible Impeller Pumps Series 350  
Models PL350-PL353

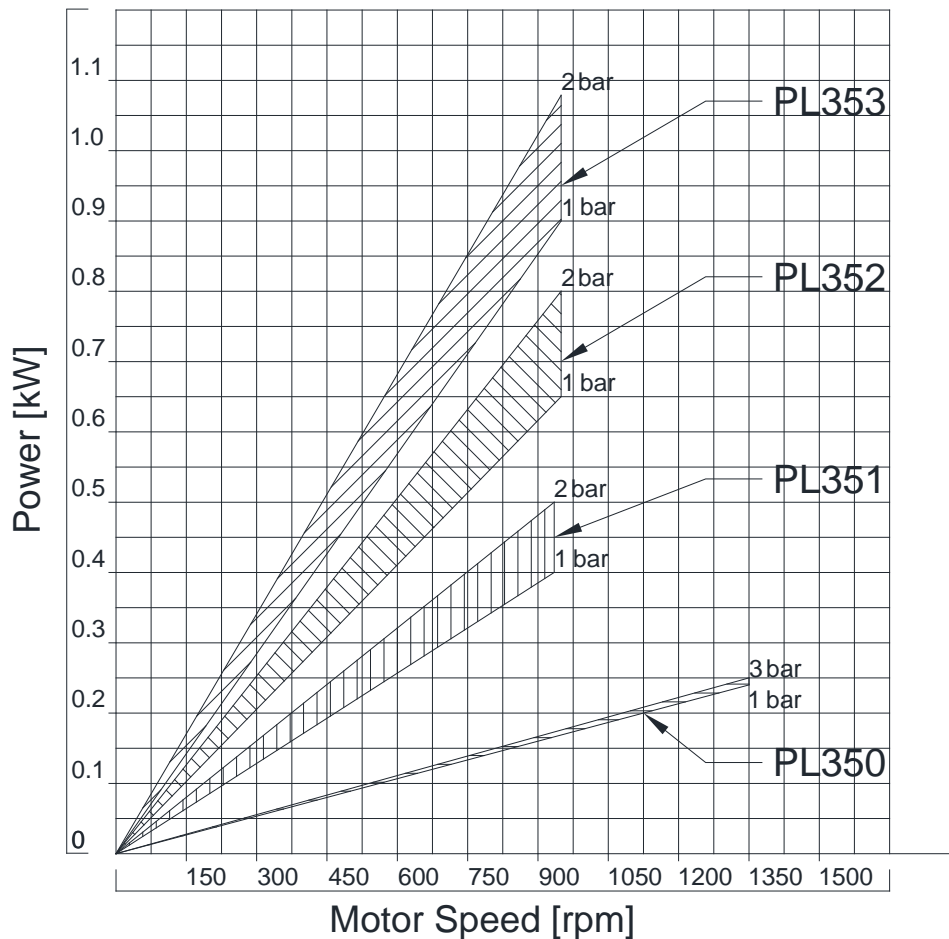
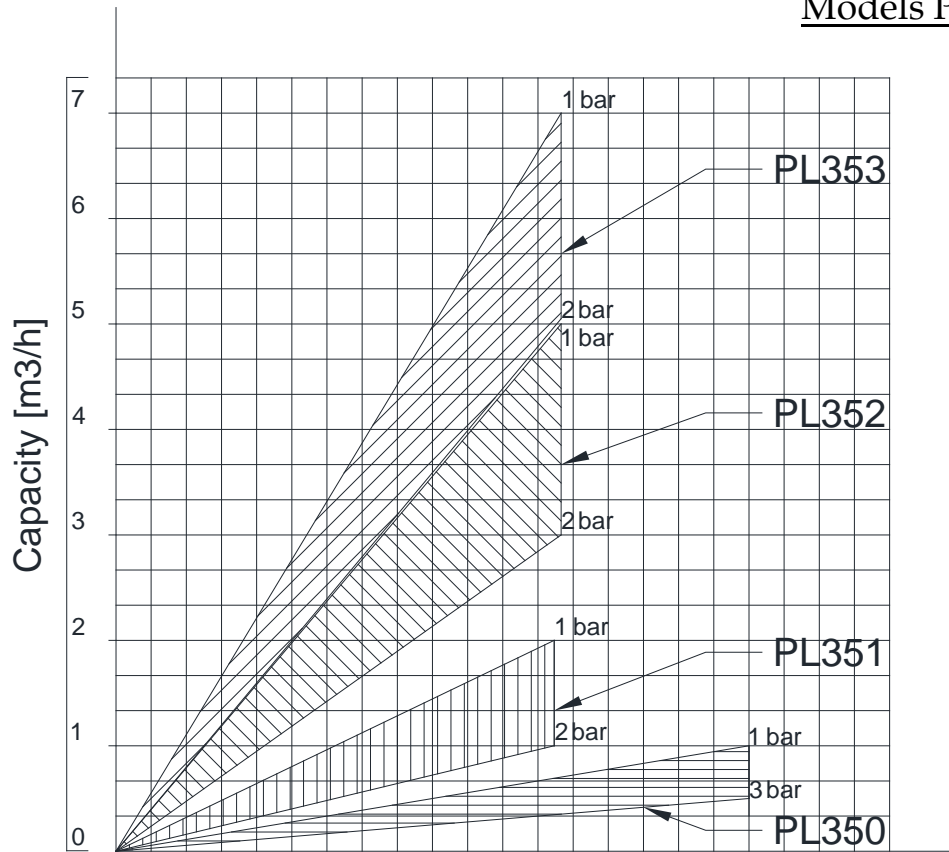

\*with fluid – water at temperature 20 °C.  
\*with pipes equal with pump's connections.

**Characteristic Curves of the Unitech Flexible Impeller Pumps Series 350**  
**Models PL354MR-PL356MR**

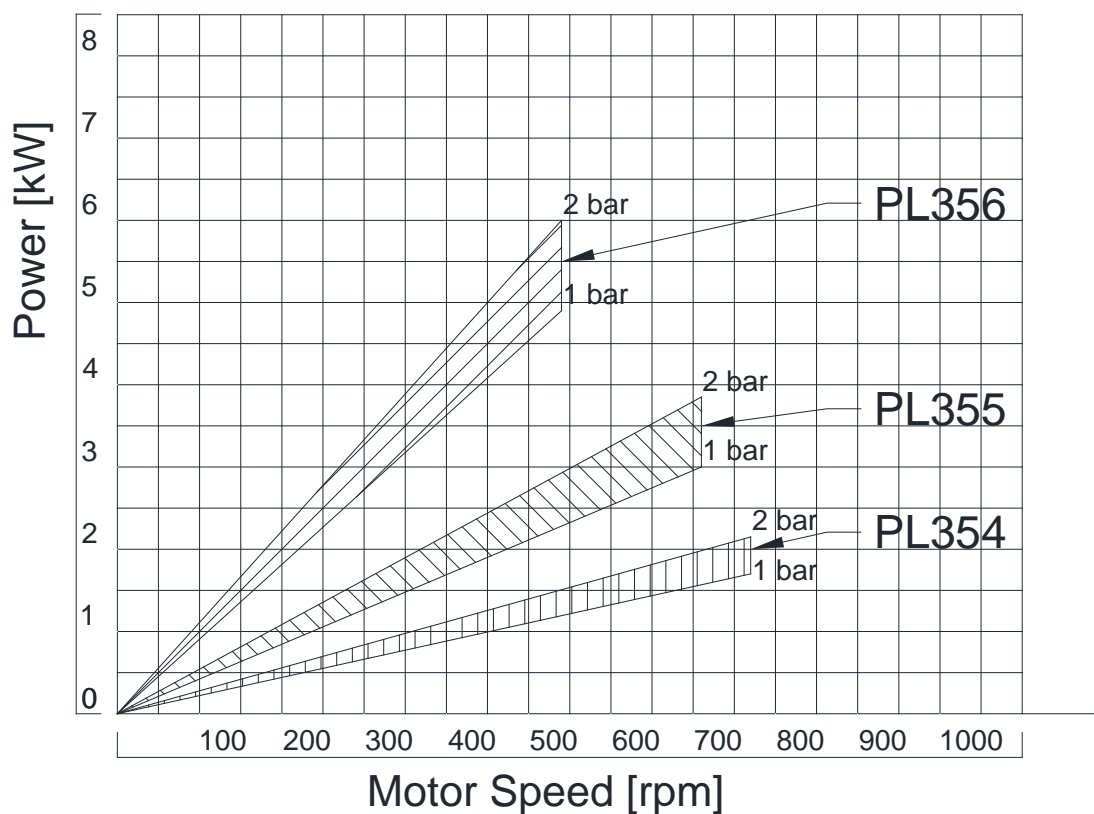
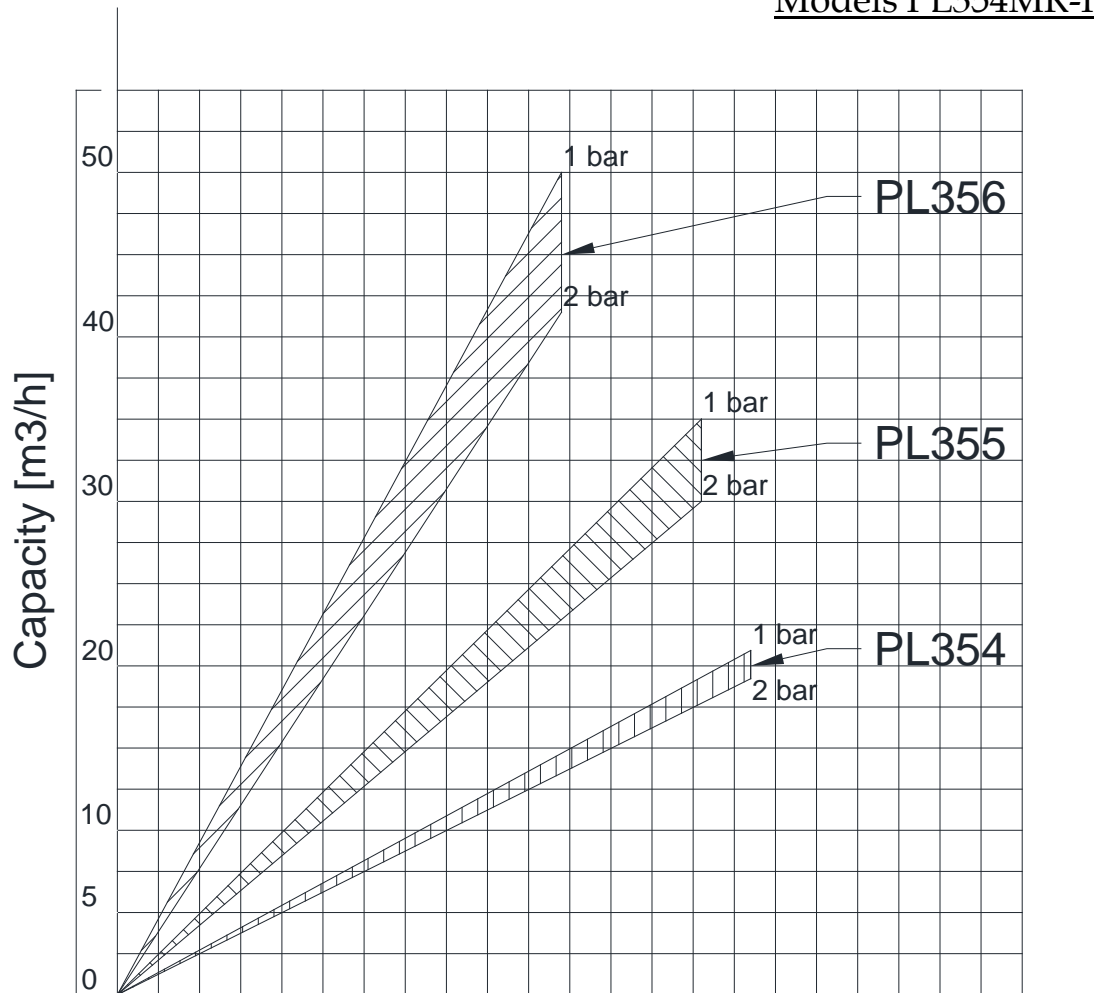

\*with fluid – water at temperature 20 °C.  
\*with pipes equal with pump's connections.

Characteristic Curves of the Unitech Flexible Impeller Pumps Series 350  
Models PL358MR

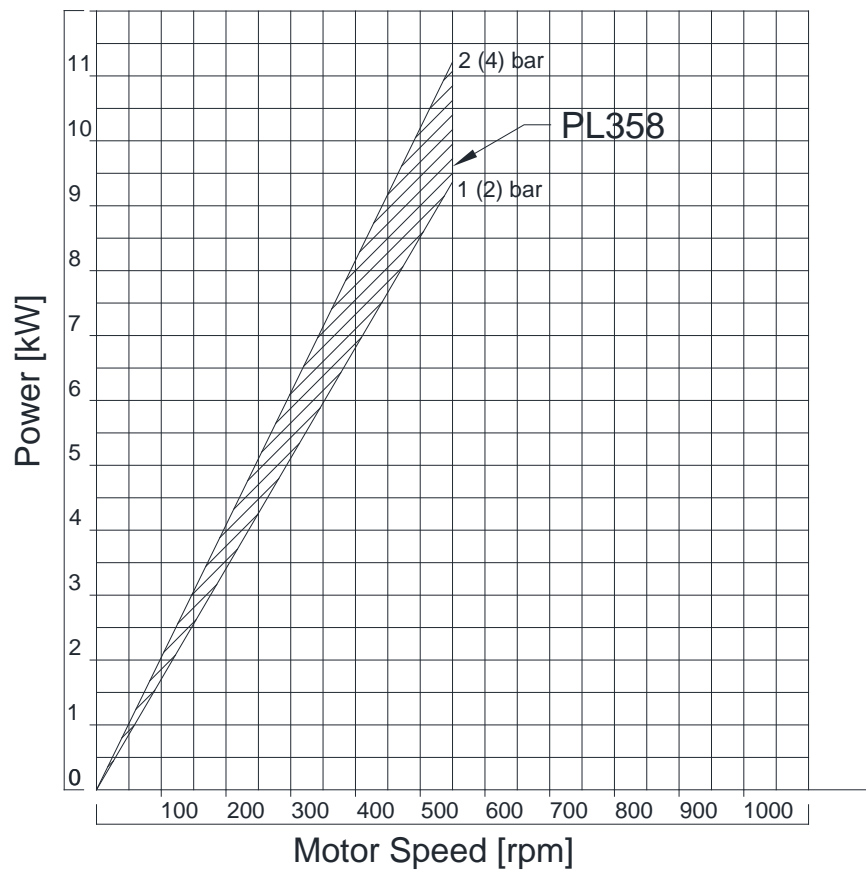
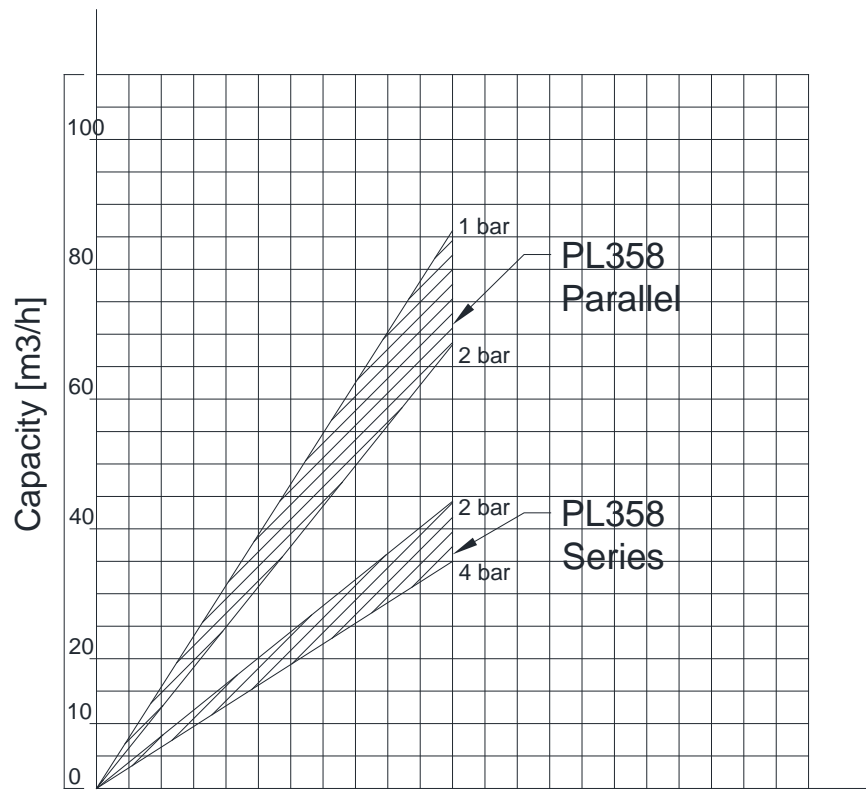

\*with fluid – water at temperature 20 °C.  
\*with pipes equal with pump's connections.

## Dimensions of the Unitech Flexible Impeller Pumps Series 350

### Models PL350K

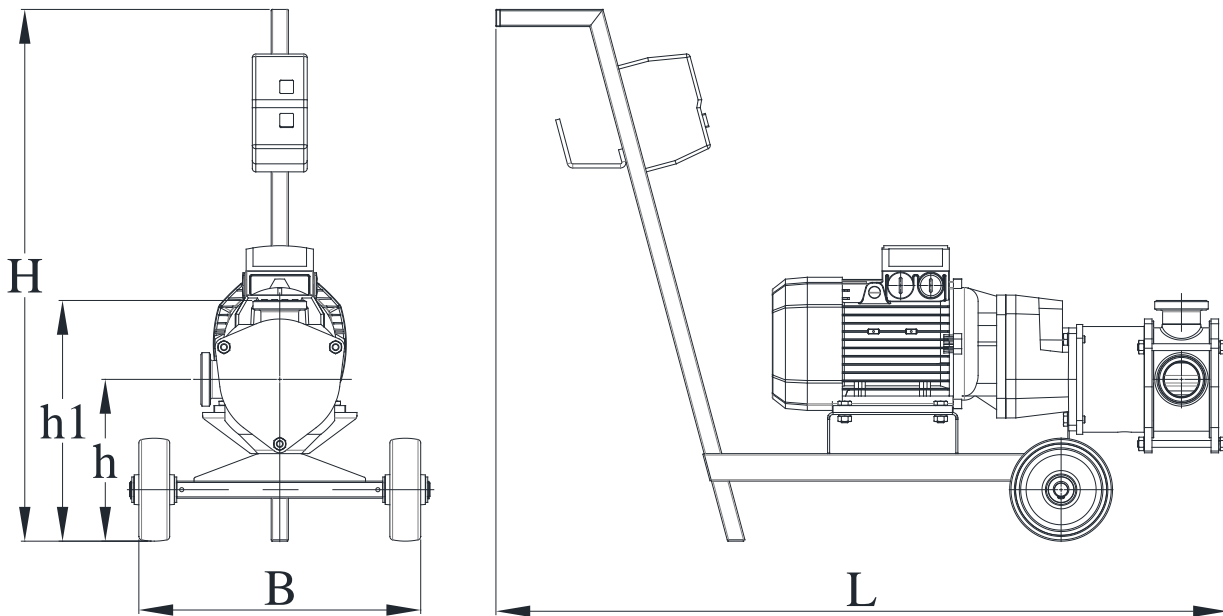

Dimensions, mm								
Model	Dy1	Dy2	L	B	H	h	h1	e
PL352K	40	40	865	360	775	253	340	88
PL353K	50	50	930	360	775	253	340	91
PL354MRK	50	50	1070	415	775	235	350	115
PL355MRK	65	65	1210	415	775	258	392	140
PL356MRK	80	80	1070	595	875	300	560	258
PL358MRK	100	100	1280	665	1090	425	600	-

6600 Kardzhali , Bulgaria  
 East Industrial Zone  
 Post box 187  
 Tel: +35936166650  
 Fax: +35936166651  
 E-mail: [unitech@unitech.bg](mailto:unitech@unitech.bg)  
 Web: [www.unitech.bg](http://www.unitech.bg)